

COOPDECH[®] Syrinjector[®]



COOPDECH[®] Syrinjector[®] PCA Set



COOPDECH[®] Syrinjector[®]

Latex-Free

60mL/Premium 120mL

(Disposable Infusion Pump)

- Coopdech Syrinjector operates by the use of atmospheric pressure. It adapts the force of vacuuming. Our patented structural designing accomplishes the most ideal flow rate, which allows the perfect stable driving pressure to the end of its solution. (Japanese Patent No. 3495045, US Patent No. 5807337)
- In comparison with the traditional infusers, the flow rate is much more stable and accurate than other driving types.
- Visible volume scale allows you to confirm the medication is flowing through pump and determine consumed medication and remaining time.
- Compact, accurate, easy to use, silent, environmental friendly.
- Various flow rates are selected easily by our patented precise flow regulator, "Spiral Flow Selector". (Japanese Patent No. 3398058, US Patent No. 6270483, Taiwanese Patent No. 106278)
- Syrinjector offers wide range of flow rate (from 0.5mL/h to 8.0mL/h)

[Precautions]

1. Sterility guaranteed if package is unopened and undamaged. Discard the product after use, do not reuse.
2. Do not use the product when administering fat emulsion preparations and drug solutions containing fat emulsion preparations; drug solutions containing oil-based ingredients; or drug solutions containing surface-active agents or solubilizing agents such as ethanol.
3. Be careful when using fat-soluble drugs, the extension tube is made of polyvinyl chloride.
4. Use of narcotics with versions of this product which drug solutions can be removed from the infusion port should only be done in the medical institutions.
5. Be sure to read the instruction manual for use carefully, and gain a thorough understanding of the product before using it.
6. Set the flow rate by taking into consideration the target site, patient's physique and age, user's experience and technique used.
7. Do not use products if the sterile package is opened or damaged. Item might be contaminated.
8. Before using the product, confirm that there are no dents, cracks or signs of excessive deterioration.
9. Avoid tightening the joint parts excessively with tightening tools, etc. The product may crack, and the drug solution may leak out.
10. Before filling the Premium 120 mL Syrinjector with drug solution, be sure to create a preliminary vacuum first.
11. Before using the product, examine the connection status of catheters, tubes and connectors, check for any tube breakage, etc., and confirm that the product will operate normally. Re-check the catheters that are to be placed inside the patient's body.
12. The Flow Selector carries the risk of fluid leakage if subjected to pressures exceeding 98 kPa (1 kgf/cm²).
13. Do not use highly viscous solutions or emulsions. They may obstruct the tubules of the flow rate control part as well as the Air Vent Filters, causing blockage.
14. Make sure to handle the drug solutions to be administered in conformity with the instructions.
15. Do not use this product other than for venous or epidural injections.
16. Avoid using the product inside hyperbaric or hypobaric environment/
17. Make sure that organic solvents such as alcohol do not come into contact with the Syrinjector's main body, Air Vent Filters, connectors or other parts, since this may cause infusion arrest or product breakage.
18. After adding the drug solution, make sure to cover the infusion port with a cap.
19. Discontinue using products that are shown to be defective, such as by fluid leakage or liquid flow-out.
20. The product's flow rate is set, assuming physiological saline solution and room temperature (25°C). Note that flow rate may change depending on the concentration, viscosity and temperature, etc., of the drug solution.
21. Note that flow rate may be affected by the length of the catheter to be connected, its inner diameter, site of insertion, etc.

22. Handle this product with care, since it may break if dropped or subjected to other physical shock.
23. Pay attention to the following when storing the product.
 - Store it in a dry place, away from water.
 - Store it at a place where there is no risk of it being influenced adversely by temperature, humidity, ventilation, sunshine, dust, or air containing salt, sulfur, etc.
 Do not remove Syrinjector from pouch until ready for use.

<References>

1. Hiroko Hirota et al.: A study of flow rate precision of portable disposable continuous infusers (syringe and balloon types). Pain Clinic 19, Supplement, 1998.
2. Ryuichi Ueda et al.: Administration of propofol via Syrinjector in pediatric MRI examinations. Clinical Anesthesiology 23, Supplement, 1999.
3. Saga Medical School: Presentations at the 29th and 30th meeting of the Japan Society of Pain Clinicians.

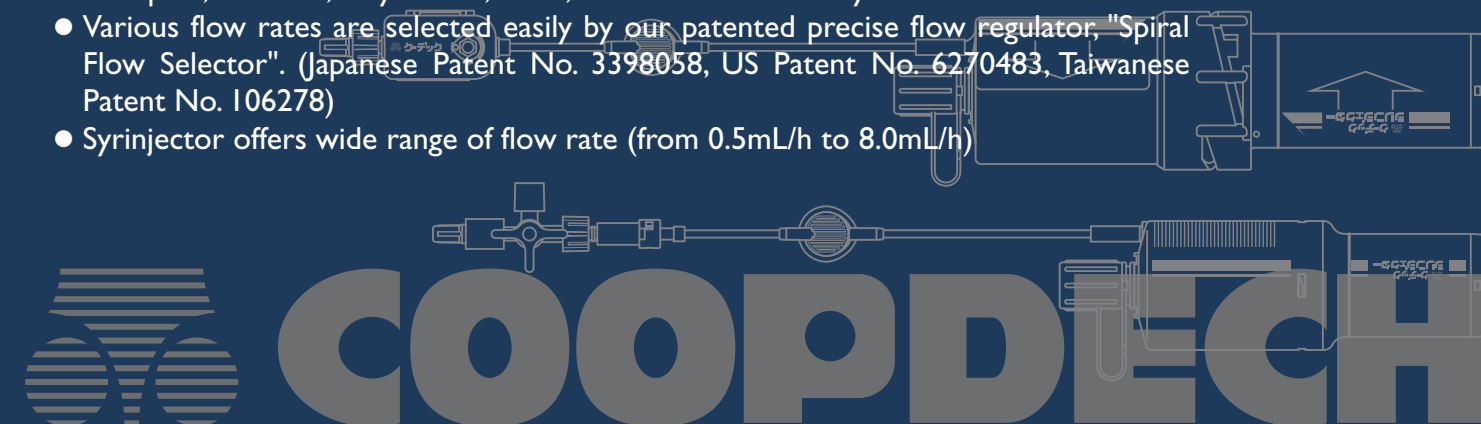
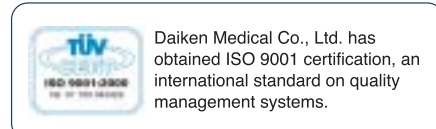
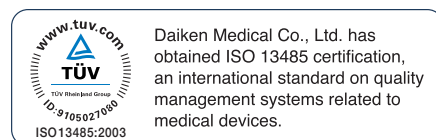

SYRINJECTOR



Syrinjector is a syringe-type infusion pump that realizes ideal flow rate precision by employing atmospheric pressure. Now with improved flow regulator and a filler inlet port for drug solutions, the Syrinjector has become even easier to use.

HOW SYRINJECTOR WORKS

The set flow rate is achieved by using a vacuum, or negative pressure.

As the drug solution is added, negative pressure is generated inside Cylinder B. This is used to expel the drug solution contained in Cylinder A. Since the negative pressure is constant, the speed of injection of the added drug solution is maintained at a constant level.

Patented

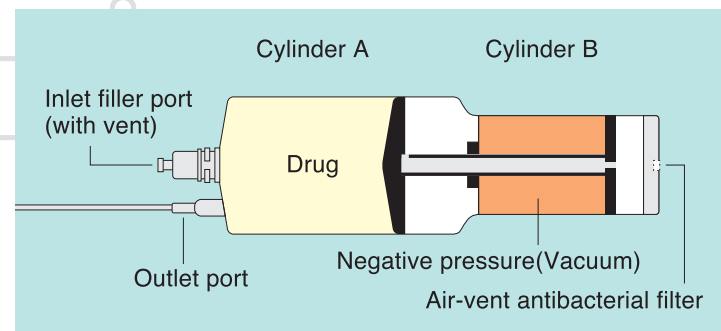

Flow rate

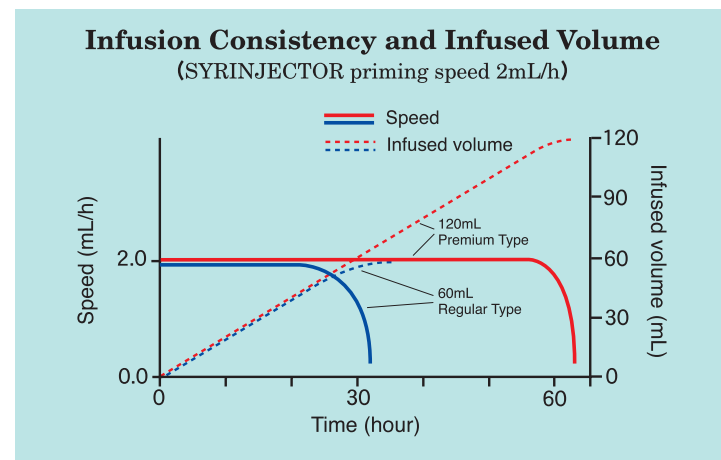

PRELIMINARY VACUUM SYSTEM

Premium 120mL demonstrates high performance due to the use of a "preliminary vacuum."

Before use, give the body approximately one-third rotation to create a preliminary vacuum. This ensures an even more stable flow rate up to the end. This feature is incorporated in the Premium 120mL model.

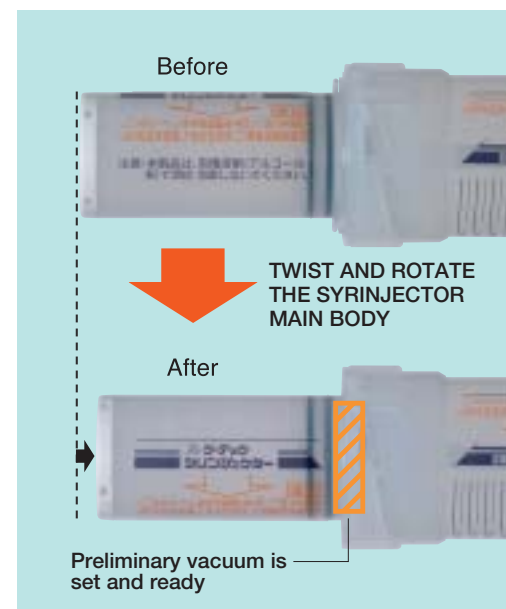

IQ VALVE

The IQ Valve facilitates the filling and removal of drug solutions.

The use of our uniquely developed two-way check valve facilitates the addition and removal of drug solutions. A series of operations, from (Filling) → (Stationary) → (Removal) can be carried out smoothly. Drug solutions never reflux during filling; similarly, no liquid leaks out during syringe removal. The force with which a drug solution is added has been sharply reduced. Filling the large-capacity Premium 120mL is easy, too.

Patented

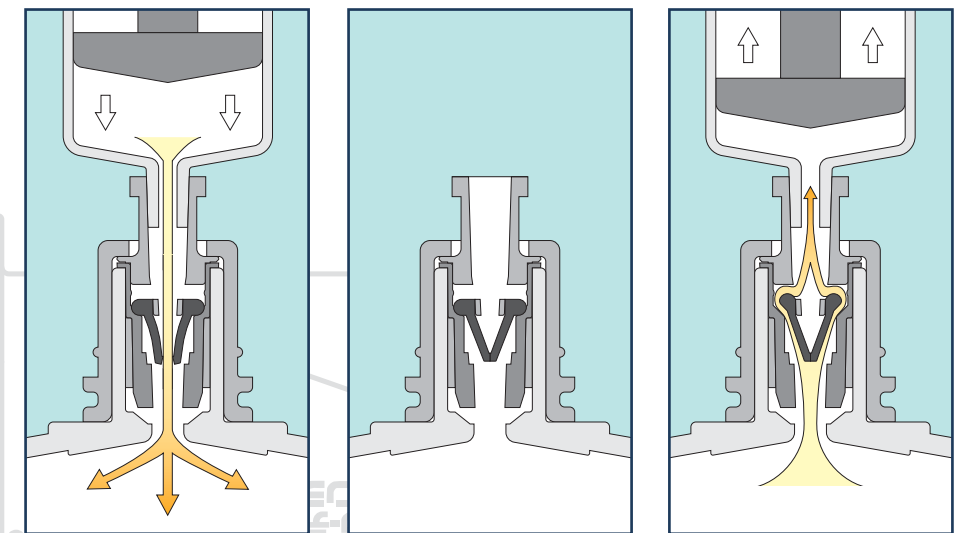

1. Inject the drug solution: The tip opens in response to the infusion pressure.

2. When stationary: The tip of the valve that had opened up is pushed by the pressure inside the pump, and closes.

3. When removing the drug solution and the air: A gap is created in the seal portion due to the pressure inside the pump and the negative pressure that is created at the upper part of the valve.

PARTS

COOPDECH's innovative flow control device by Super-precision molding."Spiral Capillary"

The disposable injection pumps using the pressure make use of a tube with small diameter on the downstream side to control the flow. The inside diameter of the hollow tube is in the range several tens to a hundred and several tens of microns. And hollow tubes are made of plastics, ceramics, and glass.

Patented



Flow Selector

The Flow Selector comes with a flow rate switchover function. It features two built-in spiral tubules (flow rate control tubules), allowing users to select three types of flow rate. It can therefore be used to suit different situations.



Mono Flow

The Mono Flow is a single flow rate type, and comes with a three-way stopcock that is ideal for bolus administration. (Type Y of Mono Flow does not come with a three-way stopcock.)

Flow selector's structure

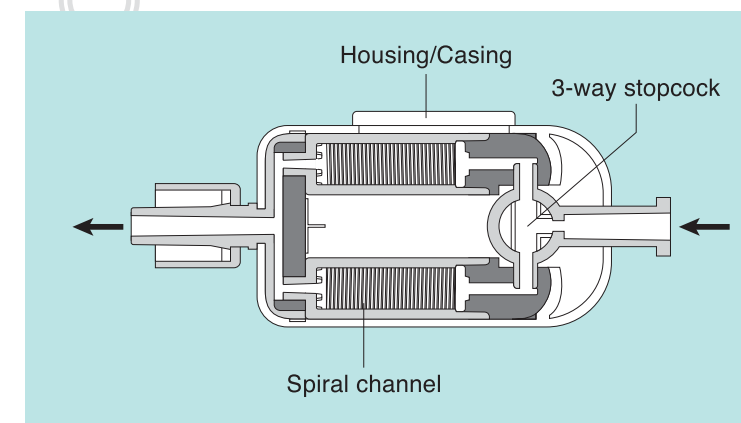

Air Vent Filter

0.2 μm disinfected Air Vent Filter has an effective filtration area of 1.65cm². It effectively removes not only air that has escaped but also bubbles and minute particles that appear in the drug solution with a rise in temperature.

SYRINJECTOR+PCA



It is easy to press by anyone, thanks to its ergonomic design and Coopdech's unique sub-balloon feature, allowing simple and effective bolus administration.

HOW PCA EQUIPMENT WORKS

The sub-balloon feature realizes an easy-to-press injection button.

With the use of Coopdech's originally developed sub-balloon, the force needed to depress the infusion button has been dramatically reduced. When the infusion button is pressed, the drug solution inside the reservoir flows in the direction of the sub-balloon and expands it. The drug solution inside the sub-balloon is administered automatically due to the sub-balloon's contraction force.

Patented

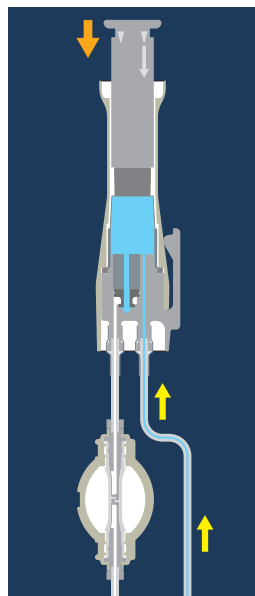

1. Press the infusion button: Press the infusion button when the reservoir is completely filled with the drug solution.

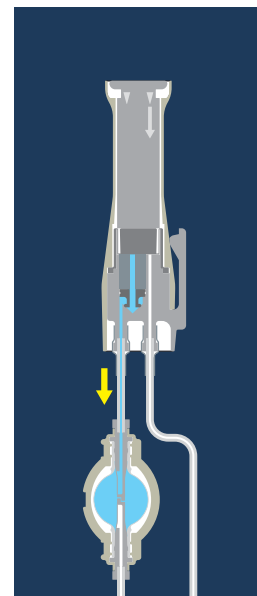

2. The sub-balloon expands: The check valve inside the PCA device's main body opens up, and the drug solution flows in the direction of the sub-balloon and expands it.

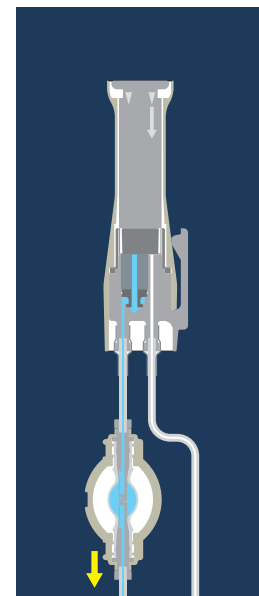

3. The drug solution is administered: Due to the sub-balloon's contraction force, the drug solution is administered automatically.

EXAMPLE 1

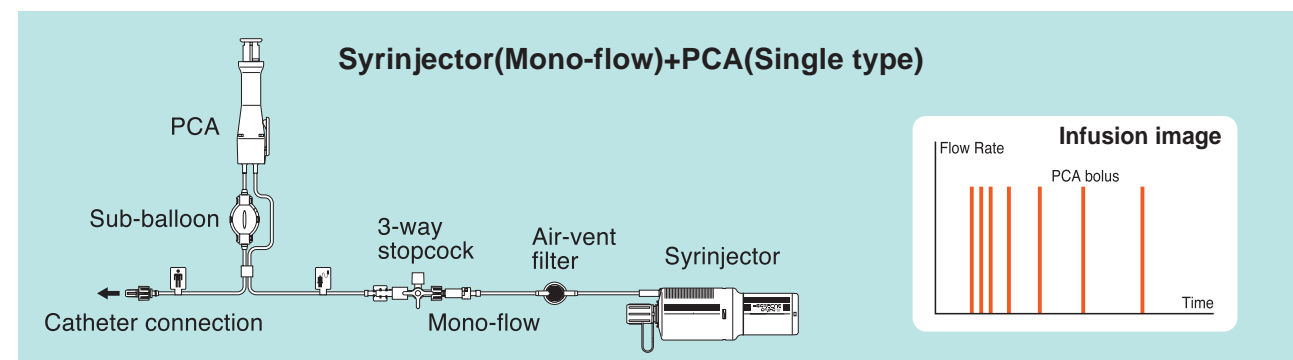

EXAMPLE 2

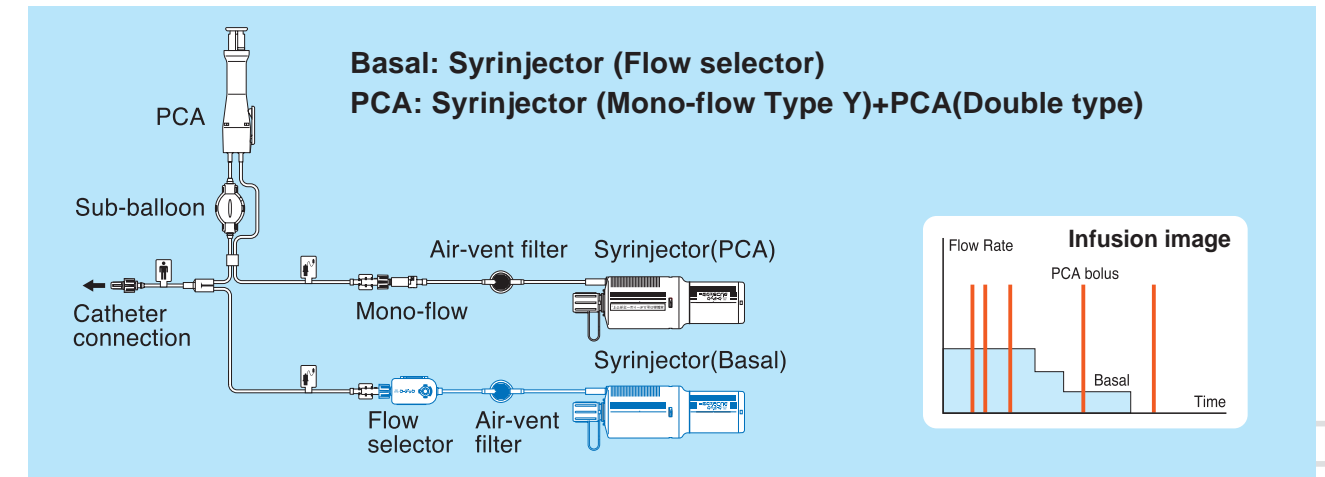

ANTI-NEEDLE VALVE

The design of the infusion port has been upgraded to prevent drug solutions from being removed.

The newly-designed infusion port comes equipped with a "defense wall" that prevents drug solutions from being removed, even if thin rods such as injection needles are inserted. This is also suitable for use with narcotics drugs. This design is used for the Syrinjector (Mono-flow Type Y) and Coopdech Syrinjector PCA Set.

Patent Pending

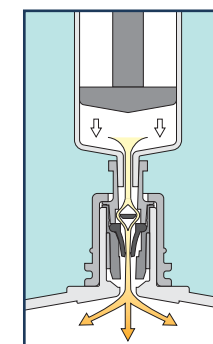

1. Infuse the drug solution: The tip of the valve opens due to the infusion pressure

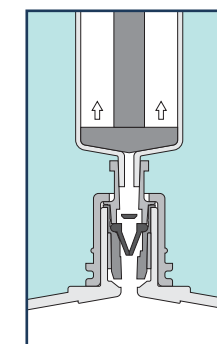

2. During suctioning: The pressure inside the pump presses the tip of the open valve and closes it to prevent reflux.

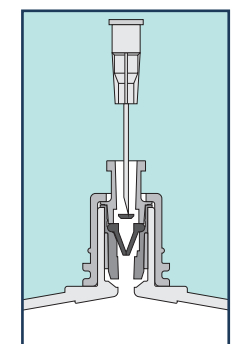

3. A structure that prevents the drug solution from being removed: The "defense wall" prevents the removal of any drug solution, even if thin rods such as injection needles are inserted.

COOPDECH SYRINJECTOR PCA SET

Coopdech Syrinjector and PCA device have been made into a set and are included in the product lineup.

- Use of colored connectors prevents erroneous connections.
- Twin connecting tubes are used to prevent the tubes from becoming entangled.
- The use of double filters facilitates the bleeding of air from the PCA device.

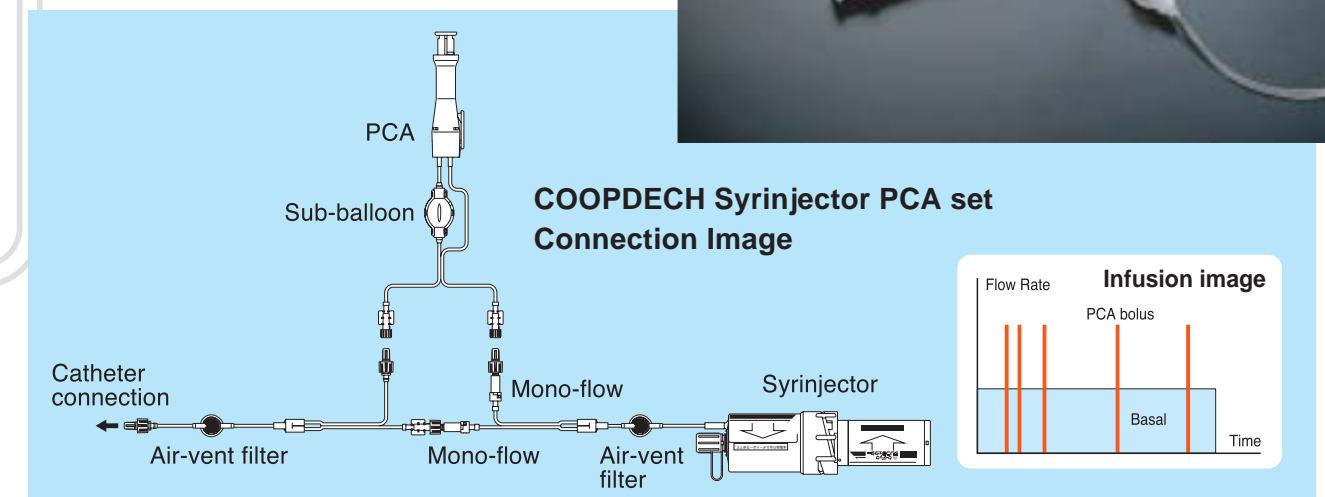

60mL Syrinjector Product Line Up

Pump Set

Contents: 60mL Pump/Flow-selector/Name label/Carrying bag

Product number	Flow-selector flow rate(mL/h)			Color	Quantity (set)
	A	B	A+B		
ISJ6-0510-EU	0.5	1.0	1.5	Green	10
ISJ6-1020-EU	1.0	2.0	3.0	Orange	10
ISJ6-2030-EU	2.0	3.0	5.0	Blue	10
ISJ6-2040-EU	2.0	4.0	6.0	Light blue	10
ISJ6-4080-EU	4.0	8.0	12.0	Yellow	10

10sets/case Sterilized Flow-selector:
Flow rate regulator with flow rate switchover function

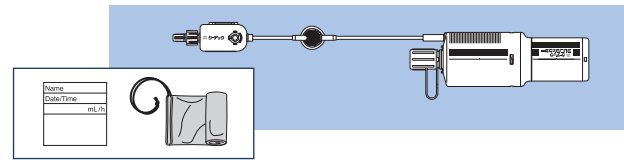

Pump Set Mono-flow Type

Contents: 60mL Pump/Mono-flow/Three-way stopcock/Name label/Carrying bag

Product number	Mono-flow flow rate(mL/h)	Color	Quantity (set)
ISJ6-05-EU	0.5	120hrs	Green
ISJ6-10-EU	1.0	60hrs	Orange
ISJ6-20-EU	2.0	30hrs	Blue
ISJ6-30-EU	3.0	20hrs	Pink
ISJ6-40-EU	4.0	15hrs	Yellow green
ISJ6-50-EU	5.0	12hrs	Ivory
ISJ6-60-EU	6.0	10hrs	Purple

10sets/case Sterilized Mono-flow: for single flow rate

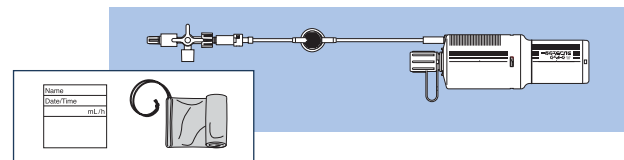

Pump Set Mono-flow Type Y

Contents: 60mL Pump/Mono-flow/Name label/Carrying bag

Product number	Mono-flow flow rate(mL/h)	Color	Quantity (set)
ISJ6-Y30-EU	3.0	20hrs	Pink

10sets/case Sterilized Mono-flow: for single flow rate

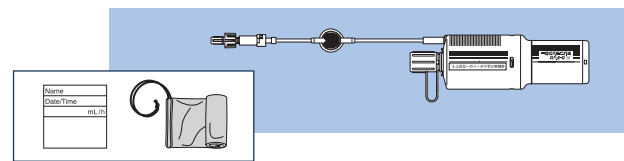

60mL Syrinjector + PCA Set Product Line Up

COOPDECH Syrinjector PCA SET

Contents: 60mL Pump/Mono-flow/PCA/Name label/Carrying bag

Set product number	Product number		Basal (mL/h)	PCA bolus volume(mL)	PCA filling time(min)	Color		Quantity (set)
	Syrinjector	PCA				Basal	PCA	
ISJ6-B0520IP1B-EU	ISJ6-B0520-EU	IP1-B-EU	0.5	1.0	30	Green	Blue	10
ISJ6-B1020IP1B-EU	ISJ6-B1020-EU	IP1-B-EU	1.0	1.0	30	Orange	Blue	10

10sets/case Sterilized Mono-flow: for single flow rate

Premium 120mL Syrinjector Product Line Up

Pump Set

Contents: 120mL Pump/Flow-selector/Name label/Carrying bag

Product number	Flow-selector flow rate(mL/h)			Color	Quantity (set)
	A	B	A+B		
ISJ12-P0510-EU	0.5	1.0	1.5	Green	10
ISJ12-P1020-EU	1.0	2.0	3.0	Orange	10
ISJ12-P2030-EU	2.0	3.0	5.0	Blue	10
ISJ12-P2040-EU	2.0	4.0	6.0	Light blue	10

10sets/case Sterilized Flow-selector:
Flow rate regulator with flow rate switchover function

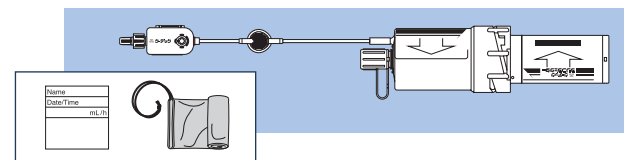

Pump Set Mono-flow Type

Contents: 120mL Pump/Mono-flow/Three-way stopcock/Name label/Carrying bag

Product number	Mono-flow flow rate(mL/h)	Color	Quantity (set)
ISJ12-10-EU	1.0	120hrs	Orange
ISJ12-20-EU	2.0	60hrs	Blue
ISJ12-30-EU	3.0	40hrs	Pink
ISJ12-40-EU	4.0	30hrs	Yellow green
ISJ12-50-EU	5.0	24hrs	Ivory

10sets/case Sterilized Mono-flow: for single flow rate

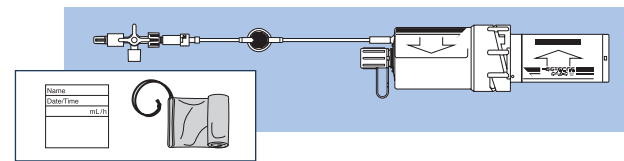

Pump Set Mono-flow Type Y

Contents: 120mL Pump/Mono-flow/Name label/Carrying bag

Product number	Mono-flow flow rate(mL/h)	Color	Quantity (set)
ISJ12-Y20-EU	2.0	60hrs	Blue
ISJ12-Y30-EU	3.0	40hrs	Pink

10sets/case Sterilized Mono-flow: for single flow rate

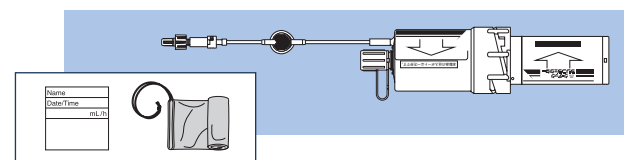

Premium 120 mL Syrinjector + PCA Set Product Line Up

COOPDECH Syrinjector PCA SET

Contents: 120mL Pump/Mono-flow(for Basal/PCA each)/PCA/Name label/Carrying bag

Set product number	Product number		Basal (mL/h)	PCA bolus volume(mL)	PCA filling time(min)	Color		Quantity (set)
	Syrinjector	PCA				Basal	PCA	
ISJ12-B0530IP1B-EU	ISJ12-B0530-EU	IP1-B-EU	0.5	1.0	20	Green	Pink	10
ISJ12-B1010IP1B-EU	ISJ12-B1010-EU	IP1-B-EU	1.0	1.0	60	Orange	Orange	10
ISJ12-B1030IP1B-EU	ISJ12-B1030-EU	IP1-B-EU	1.0	1.0	20	Orange	Pink	10
ISJ12-B1060IP1B-EU	ISJ12-B1060-EU	IP1-B-EU	1.0	1.0	10	Orange	Purple	10
ISJ12-B2020IP1B-EU	ISJ12-B2020-EU	IP1-B-EU	2.0	1.0	30	Blue	Blue	10
ISJ12-B2030IP1B-EU	ISJ12-B2030-EU	IP1-B-EU	2.0	1.0	20	Blue	Pink	10
ISJ12-B4030IP1B-EU	ISJ12-B4030-EU	IP1-B-EU	4.0	1.0	20	Yellow green	Pink	10
ISJ12-B0530IP3B-EU	ISJ12-B0530-EU	IP3-B-EU	0.5	3.0	60	Green	Pink	10
ISJ12-B0560IP3B-EU	ISJ12-B0560-EU	IP3-B-EU	0.5	3.0	30	Green	Purple	10
ISJ12-B1010IP3B-EU	ISJ12-B1010-EU	IP3-B-EU	1.0	3.0	180	Orange	Orange	10
ISJ12-B1030IP3B-EU	ISJ12-B1030-EU	IP3-B-EU	1.0	3.0	60	Orange	Pink	10
ISJ12-B2010IP3B-EU	ISJ12-B2010-EU	IP3-B-EU	2.0	3.0	180	Blue	Orange	10
ISJ12-B2020IP3B-EU	ISJ12-B2020-EU	IP3-B-EU	2.0	3.0	90	Blue	Blue	10
ISJ12-B2030IP3B-EU	ISJ12-B2030-EU	IP3-B-EU	2.0	3.0	60	Blue	Pink	10
ISJ12-B2060IP3B-EU	ISJ12-B2060-EU	IP3-B-EU	2.0	3.0	30	Blue	Purple	10
ISJ12-B2080IP3B-EU	ISJ12-B2080-EU	IP3-B-EU	2.0	3.0	22.5	Blue	White	10
ISJ12-B3010IP3B-EU	ISJ12-B3010-EU	IP3-B-EU	3.0	3.0	180	Pink	Orange	10
ISJ12-B3030IP3B-EU	ISJ12-B3030-EU	IP3-B-EU	3.0	3.0	60	Pink	Pink	10
ISJ12-B3080IP3B-EU	ISJ12-B3080-EU	IP3-B-EU	3.0	3.0	22.5	Pink	White	10
ISJ12-B4030IP3B-EU	ISJ12-B4030-EU	IP3-B-EU	4.0	3.0	60	Yellow green	Pink	10
ISJ12-B4060IP3B-EU	ISJ12-B4060-EU	IP3-B-EU	4.0	3.0	30	Yellow green	Purple	10
ISJ12-B5030IP3B-EU	ISJ12-B5030-EU	IP3-B-EU	5.0	3.0	60	Ivory	Pink	10
ISJ12-B5060IP3B-EU	ISJ12-B5060-EU	IP3-B-EU	5.0	3.0	30	Ivory	Purple	10
ISJ12-B6030IP3B-EU	ISJ12-B6030-EU	IP3-B-EU	6.0	3.0	60	Purple	Pink	10
ISJ12-B6060IP3B-EU	ISJ12-B6060-EU	IP3-B-EU	6.0	3.0	30	Purple	Purple	10

10sets/case Sterilized Mono-flow: for single flow rate

PCA Product Line Up

PCA(Single type)

Product number	Capacity	Remarks	Quantity (set)
IP3-EU	3mL	only for Bolus	10
IP1-EU	1mL	only for Bolus	10

10sets/case Sterilized Syrinjector pump for PCA is requested.

PCA Type Y(Double type)

Product number	Capacity	Remarks	Quantity (set)
IP3-Y-EU	3mL	Bolus + Basal	10
IP1-Y-EU	1mL	Bolus + Basal	10

10sets/case Sterilized Syrinjector pump for PCA is requested.

Optional Product Line Up

Carrying bag

Product number	Quantity(set)
ISJ-BAG-EU	10

10sets/case for 60mL/120mL



● Please note that specifications and outward appearance may change without notice for enhancement purposes.